



## **4" 6" & 8" SP SERIES SUBMERSIBLE PUMPS 3000 RPM • 50 Hz**

**5 • 10 • 18 • 25 • 40 • 70 • 90 • 150 • 230 • 300 • 400 • 500 GPM**

**SP Series Submersible Pumps** are manufactured using high quality materials and are designed to deliver years of dependable service. SP Series are comprised of a large selection of pump models ranging from 1/2 HP thru 125 HP with a broad variety of capacities (5 GPM - 500 GPM).

**Recommended for Pumping Clear Water**

### **QUALITY FEATURES**

**STAINLESS STEEL CONSTRUCTION  
DESIGNED AND BUILT FOR YEARS OF  
TROUBLE-FREE OPERATION**

**STAINLESS STEEL DISCHARGE HEAD  
WITH BUILT-IN CHECK VALVE**

**HIGH-EFFICIENCY STAINLESS STEEL  
IMPELLERS AND DIFFUSERS**

**STAINLESS STEEL SUCTION SCREEN**

**STAINLESS STEEL SHAFT AND  
COUPLING**

**STAINLESS STEEL NEMA-FACED  
MOUNTING BRACKET**

*Specifications subject to change without notice.*





### DESIGNATION

**Series** \_\_\_\_\_ **SP** \_\_\_\_\_ **230 - 12 - 30**  
**Capacity - U.S. GPM** \_\_\_\_\_  
**Number of Stages** \_\_\_\_\_  
**Horsepower** \_\_\_\_\_

8" Pumps Feature:  
Cast Stainless Steel 5" Discharge Head & NEMA Mounting Bracket

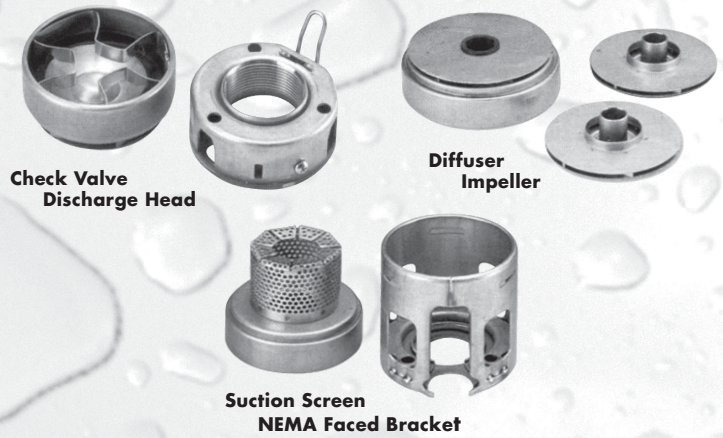

### MATERIALS OF CONSTRUCTION

COMPONENT	MATERIALS	STANDARD
Valve Casing	Stainless Steel	304
Valve Cup	Stainless Steel	304
Valve Seat	Stainless Steel	304
Diffuser	Stainless Steel	304
Neck Ring	NBR	
Diffuser Bearing	NBR	
Split Cone Nut	Stainless Steel	304
Split Cone	Stainless Steel	304
Impeller	Stainless Steel	304
NEMA Mounting Bracket	Stainless Steel	304
Strainer	Stainless Steel	304
Shaft	Stainless Steel	304
Strap	Stainless Steel	304
Nut for Strap	Stainless Steel	304
Coupling	Stainless Steel	304
Valve Guide	Stainless Steel	304

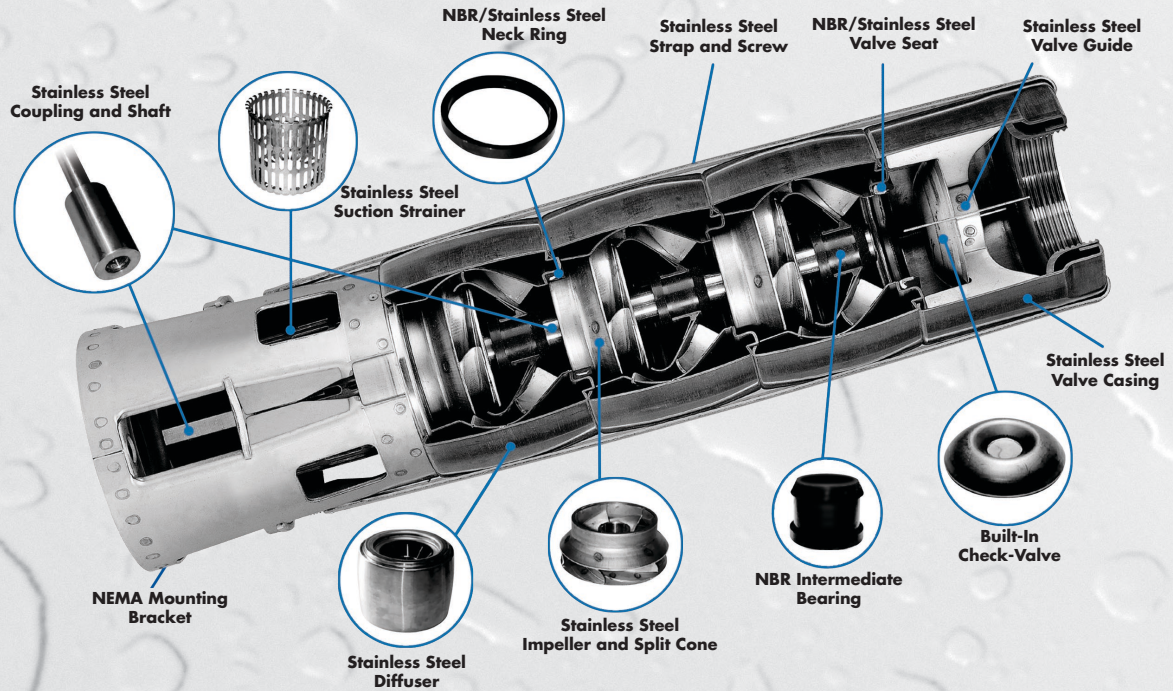
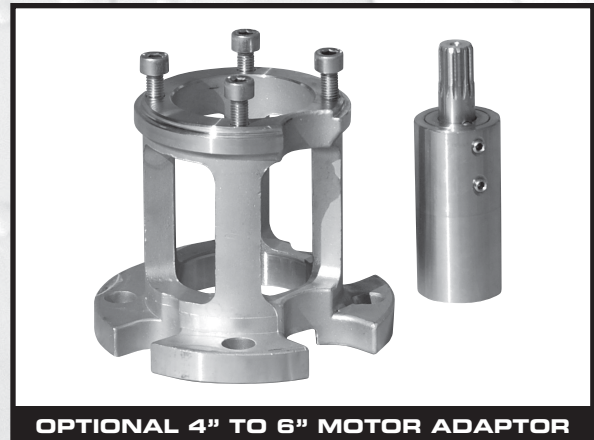

**DISTRIBUTED BY:**



OUR PUMPS ARE POWERED BY  
**Franklin Electric**





**4" MODEL SP-05**  
50 Hz - 3000 RPM



1 1/4" Discharge

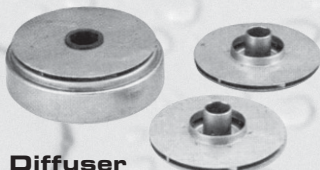

Diffuser  
Impeller

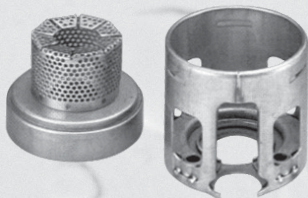

Suction Screen  
NEMA Faced Bracket

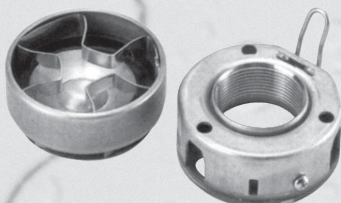

Check Valve  
Discharge Head

**SP SERIES PERFORMANCE CURVES**  
5 GPM MAXIMUM EFFICIENCY

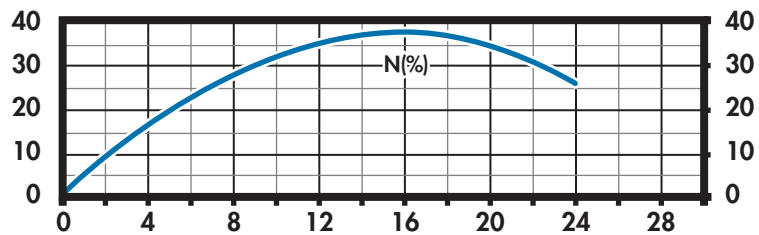
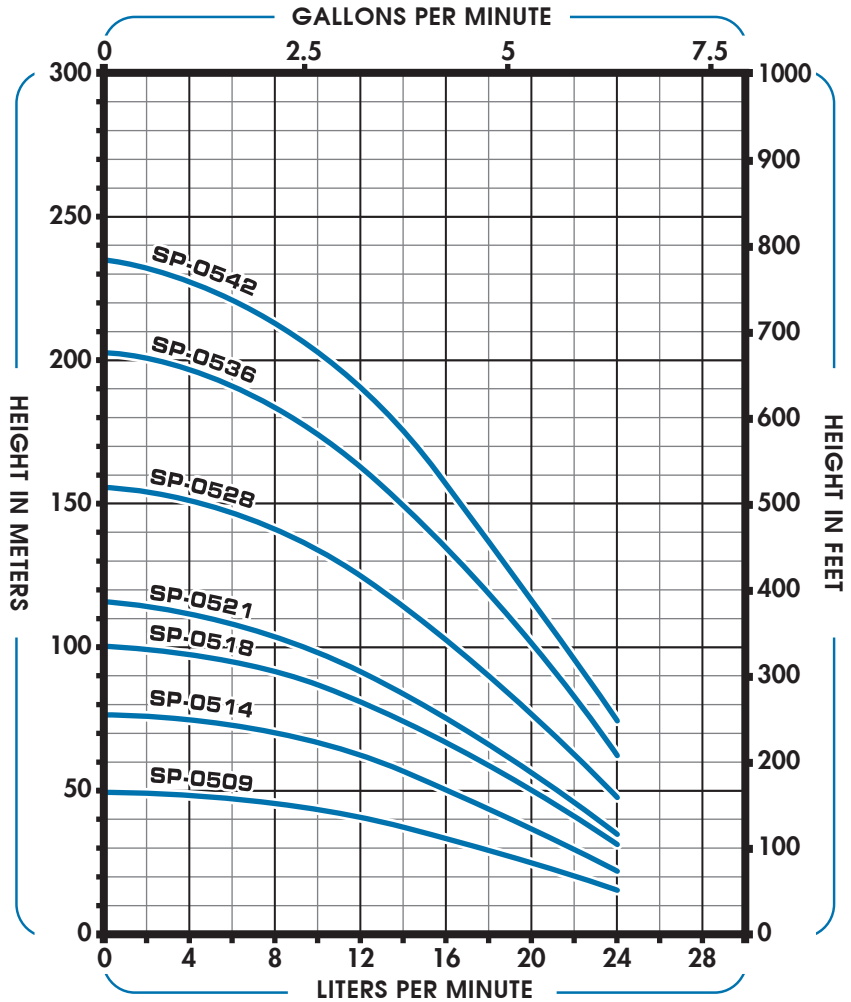

MODEL	STAGES	HP	Quantity Delivered																LENGTH mm	WEIGHT kg
			l/min	5	10	15	20	25	30	35	40	45	50	60	70	80				
			m <sup>3</sup> /h	0.3	0.6	0.9	1.2	1.5	1.8	2.1	2.4	2.7	3.0	3.6	4.2	4.8				
			Total Head in Meters																	
SP-0509	9	1/2	52	48	45	36	27	14											343	3.2
SP-0514	14	1/2	79	76	68	56	38	21											448	4.2
SP-0518	18	3/4	102	96	88	72	52	27											542	5.0
SP-0521	21	3/4	118	112	100	81	58	30											195	5.6
SP-0528	28	1	158	153	138	111	78	42											742	7.0
SP-0536	36	1 1/2	205	195	175	134	103	54											945	9.1
SP-0542	42	1 1/2	238	235	203	167	118	67											1071	10.4





**4" MODEL SP-10**  
50 Hz - 3000 RPM



1 1/4" Discharge

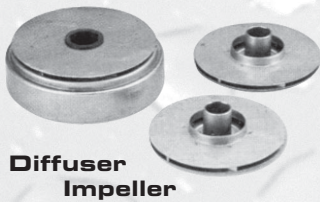

Diffuser  
Impeller

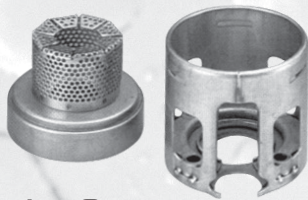

Suction Screen  
NEMA Faced Bracket

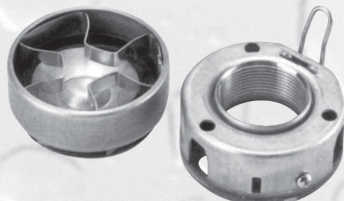

Check Valve  
Discharge Head

**SP SERIES PERFORMANCE CURVES**  
10 GPM MAXIMUM EFFICIENCY

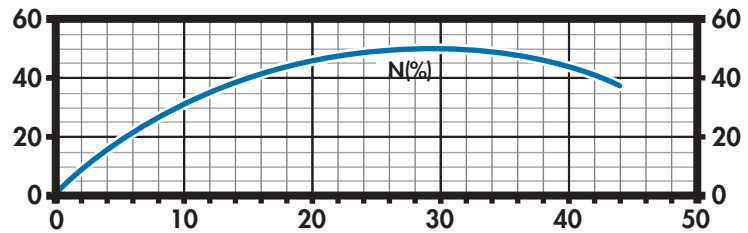
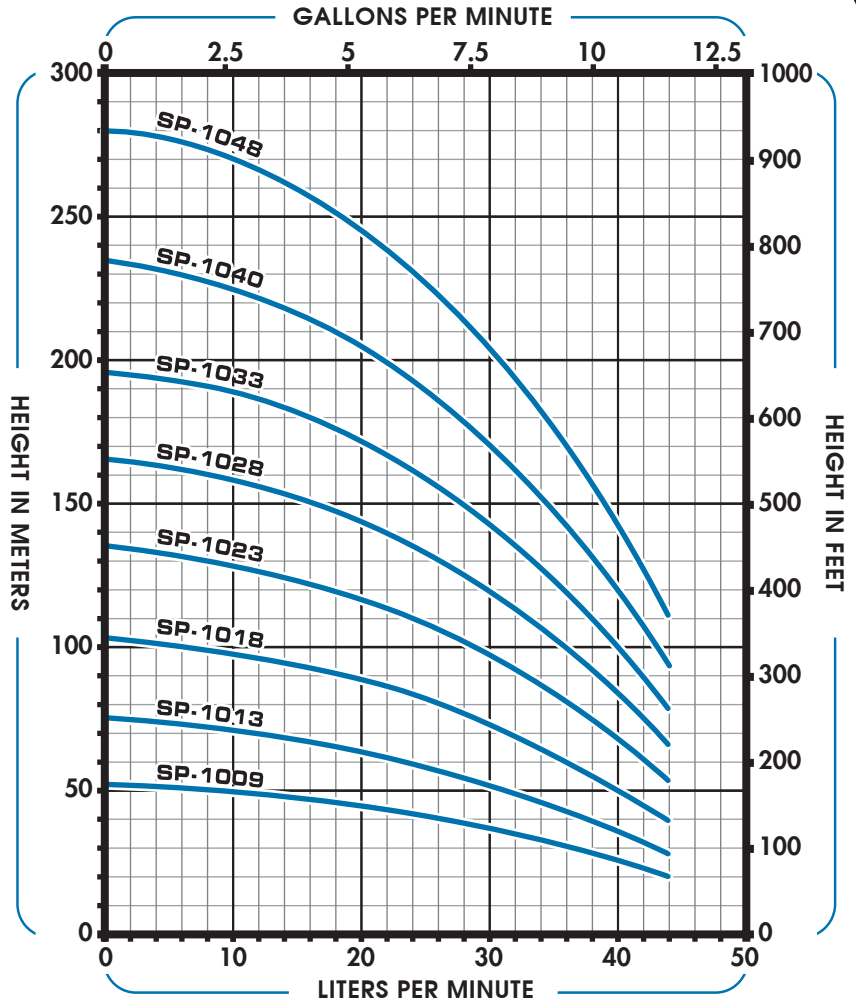

MODEL	STAGES	HP	Quantity Delivered																LENGTH mm	WEIGHT kg
			l/min	15	20	25	30	35	40	45	50	60	70	80	90	100				
			m <sup>3</sup> /h	0.9	1.2	1.5	1.8	2.1	2.4	2.7	3.0	3.6	4.2	4.8	5.4	6.0				
			Total Head in Meters																	
SP-1009	9	1/2	53	48	45	42	38	33	26										343	3.1
SP-1013	13	3/4	77	68	64	58	54	46	38										427	4.0
SP-1018	18	1	104	94	89	83	74	64	51										532	4.9
SP-1023	23	1 1/2	136	124	118	108	98	84	69										637	6.0
SP-1028	28	2	166	154	145	134	122	105	86										742	6.8
SP-1033	33	2	195	183	173	159	143	124	102										847	7.6
SP-1040	40	3	235	218	205	190	170	147	119										1029	9.8
SP-1048	48	3	280	261	246	228	204	178	143										1197	11.1





**4" MODEL SP-18**  
50 Hz - 3000 RPM



1 1/4" Discharge

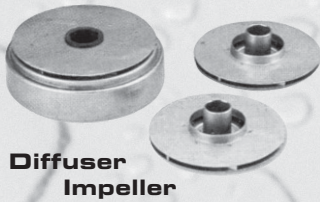

Diffuser  
Impeller

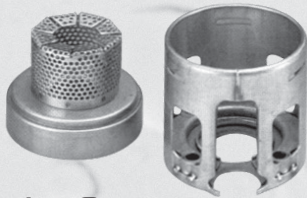

Suction Screen  
NEMA Faced Bracket

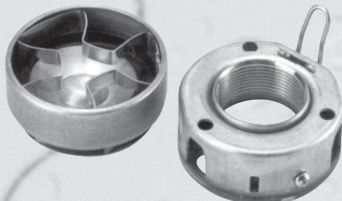

Check Valve  
Discharge Head

**SP SERIES PERFORMANCE CURVES**  
18 GPM MAXIMUM EFFICIENCY

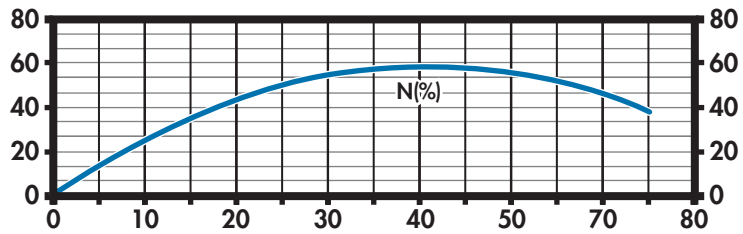
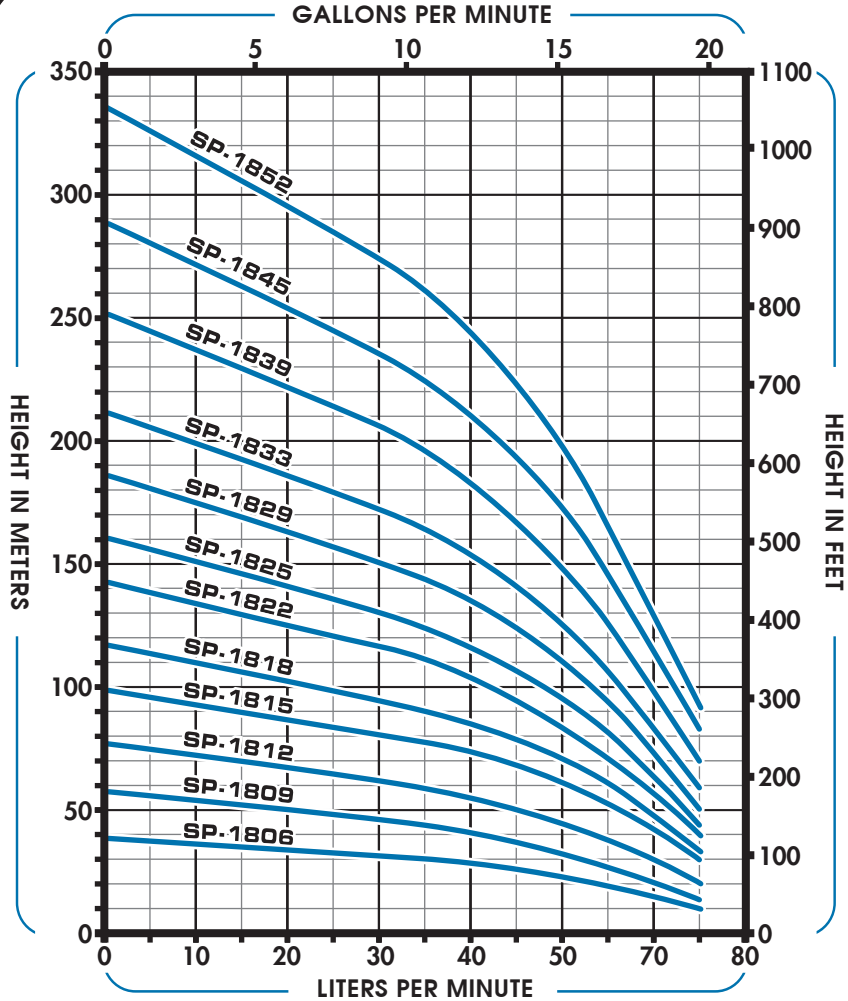

MODEL	STAGES	HP	Quantity Delivered														LENGTH mm	WEIGHT kg	
			l/min		Total Head in Meters														
			0	25	30	35	40	45	50	60	70	80	90	100	120	140			
m <sup>3</sup> /h	1.5	1.8	2.1	2.4	2.7	3.0	3.6	4.2	4.8	5.4	6.0	7.2	8.4						
SP-1806	6	1/2	38	33	32	31	30	28	26	22	14							280	2.5
SP-1809	9	3/4	57	49	47	46	44	41	38	30	19							343	3.1
SP-1812	12	1	77	66	64	62	58	56	52	43	28							406	2.7
SP-1815	15	1 1/2	97	85	83	80	77	74	69	57	40							469	4.4
SP-1818	18	1 1/2	116	101	97	94	90	85	80	67	45							532	4.9
SP-1822	22	2	143	127	120	115	110	105	97	80	54							616	5.7
SP-1825	25	2	160	139	134	128	124	117	110	90	60							679	6.2
SP-1829	29	3	185	160	155	149	143	136	127	103	70							763	7.1
SP-1833	33	3	211	183	177	172	164	155	145	118	80							847	7.8
SP-1839	39	4	250	219	213	204	195	185	172	138	94							993	9.5
SP-1845	45	4	288	250	243	233	224	213	199	162	110							1134	10.5
SP-1852*	52	5 1/2	334	291	282	272	261	247	230	184	123							1281	12.2

\*It is recommended to use the next rating of horsepower available









**4" MODEL SP-40**  
50 Hz - 3000 RPM



2" Discharge

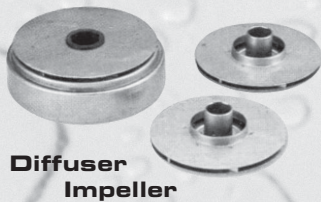

Diffuser  
Impeller

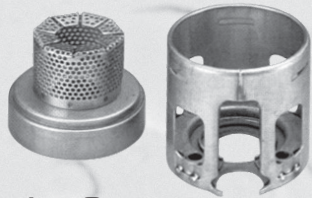

Suction Screen  
NEMA Faced Bracket

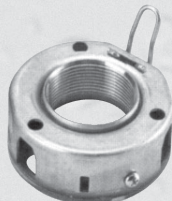

Check Valve  
Discharge Head

**SP SERIES PERFORMANCE CURVES**  
40 GPM MAXIMUM EFFICIENCY

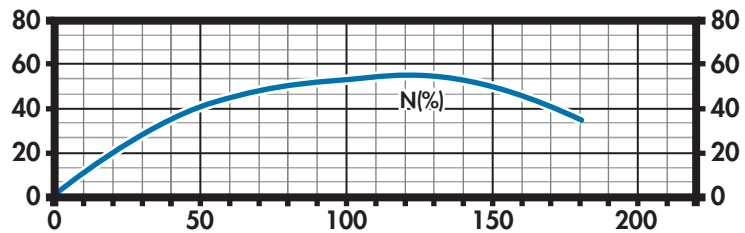
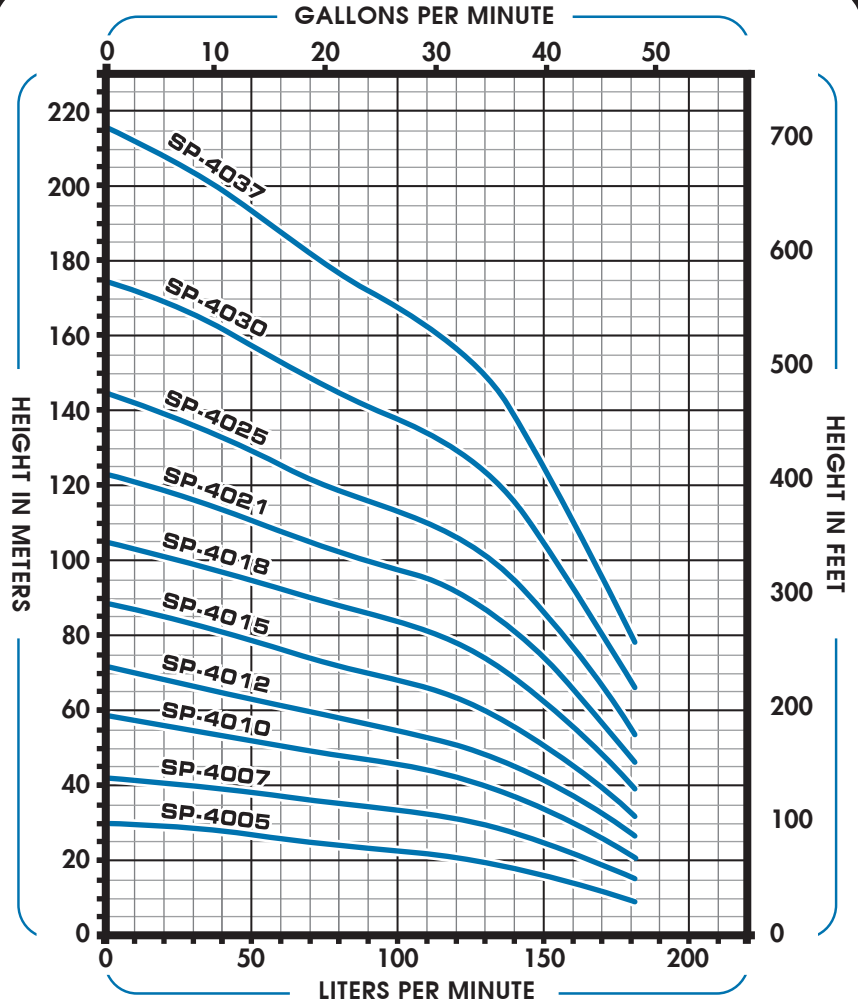

MODEL	STAGES	HP	Quantity Delivered																LENGTH mm	WEIGHT kg
			Total Head in Meters																	
			l/min m <sup>3</sup> /h	0	2.4	2.7	3.0	3.6	4.2	4.8	5.4	6.0	7.2	8.4	9.6	10.8	12			
SP-4005	5	1	30	28	27	26	26	25	24	23	22	21	19	15	12	407	4.3			
SP-4007	7	1½	41	38	37	36	36	35	35	34	34	32	27	24	17	491	5.3			
SP-4010	10	2	58	54	53	52	51	49	47	47	46	43	38	32	25	617	6.8			
SP-4012	12	3	71	65	64	63	61	60	58	57	55	52	47	40	31	701	7.8			
SP-4015	15	3	87	80	79	78	76	74	72	70	68	64	57	49	38	827	9.2			
SP-4018	18	4	104	98	96	95	93	90	88	86	84	79	72	60	47	953	10.5			
SP-4021*	21	5½	122	114	113	111	107	105	102	100	98	93	85	72	55	1079	12.4			
SP-4025*	25	5½	144	133	131	128	126	123	119	116	114	107	97	84	64	1247	15.5			
SP-4030	30	7½	174	163	160	157	154	149	145	142	139	131	120	103	79	1457	17.2			
SP-4037	37	7½	215	199	196	194	188	183	177	173	169	160	145	122	93	1751	26.2			

\*It is recommended to use the next rating of horsepower available





**4" MODEL SP-70**  
50 Hz - 3000 RPM



2" Discharge

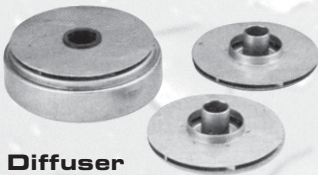

Diffuser  
Impeller

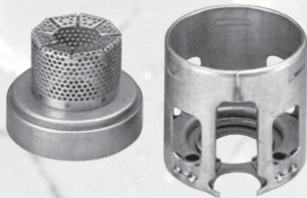

Suction Screen  
NEMA Faced Bracket

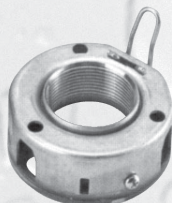

Check Valve  
Discharge Head

**SP SERIES PERFORMANCE CURVES**  
70 GPM MAXIMUM EFFICIENCY

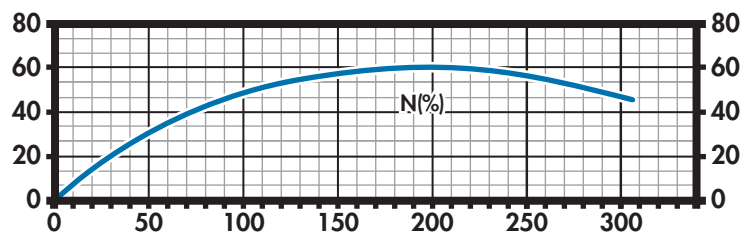
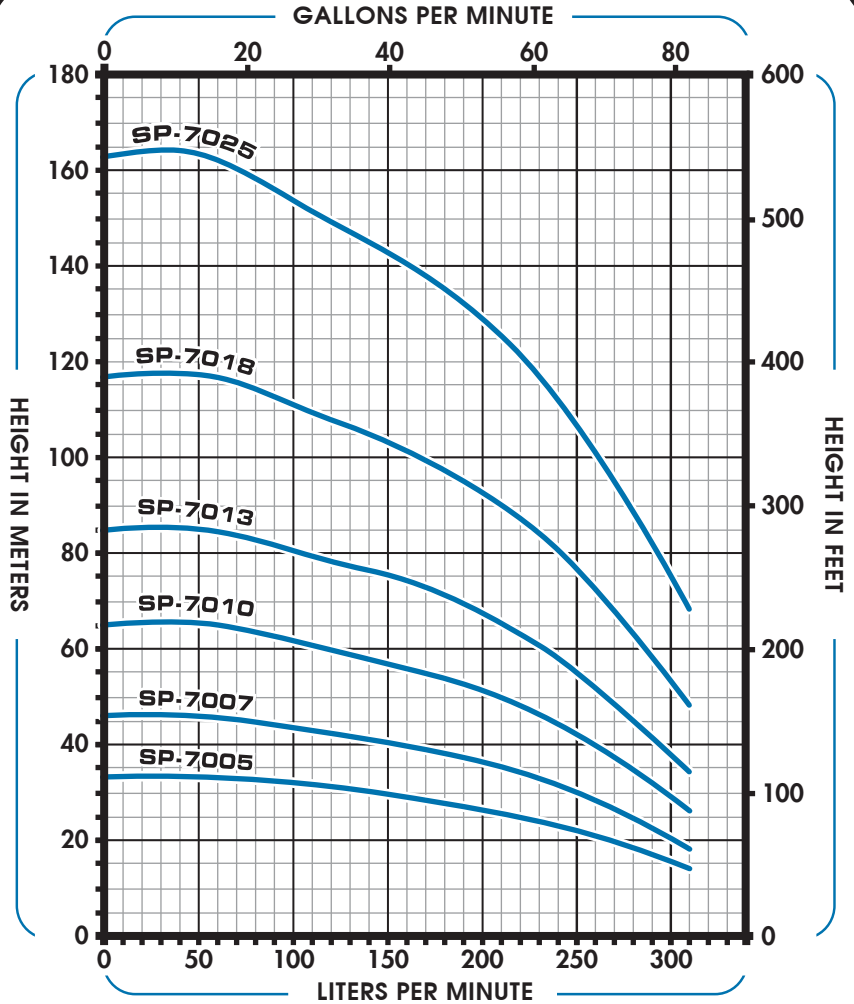

MODEL	STAGES	HP	Quantity Delivered													LENGTH mm	WEIGHT kg		
			l/min	0	100	120	140	160	180	200	250	300	350	400	450			500	550
			m <sup>3</sup> /h	0	6.0	7.2	8.4	9.6	10.8	12	15	18	21	24	27			30	33
Total Head in Meters																			
SP-7005	5	2	33	32	31	30	28	27	26	22	16					506	5.3		
SP-7007	7	3	46	44	43	42	40	37	36	30	20					636	6.6		
SP-7010	10	4	65	62	60	58	57	54	52	43	29					831	8.7		
SP-7013*	13	5 1/2	84	80	78	77	74	72	67	56	38					1026	10.7		
SP-7018	18	7 1/2	117	111	108	104	102	97	93	77	54					1351	14.1		
SP-7025	25	10	163	154	149	145	141	135	129	107	75					1806	18.9		

\*It is recommended to use the next rating of horsepower available





**6" MODEL SP-90**  
50 Hz - 3000 RPM



3" Discharge



Stainless Steel Coupling and Shaft



Stainless Steel Suction Strainer



Stainless Steel Diffuser



Stainless Steel Impeller and Split Cone



Stainless Steel Check Valve

**SP SERIES PERFORMANCE CURVES**  
90 GPM MAXIMUM EFFICIENCY

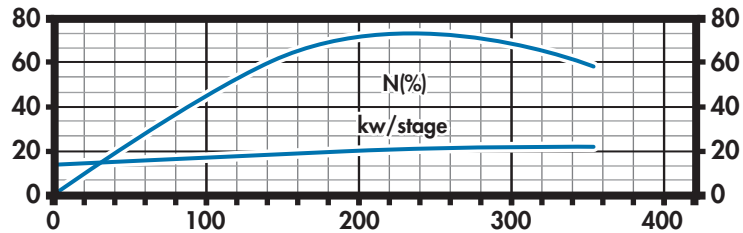
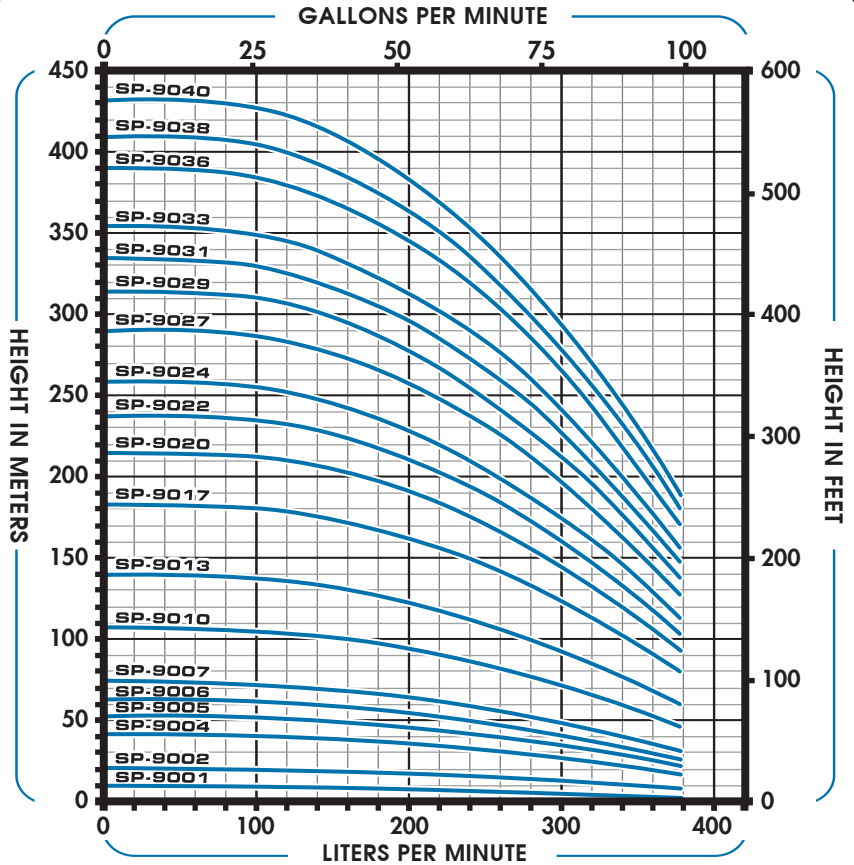

MODEL	STAGES	HP	Quantity Delivered																L F T H E I G H T m m	W E I G H T k g
			Total Head in Meters																	
			l/min m <sup>3</sup> /h	0	50	100	150	200	250	300	350	383	400	450	500	550	600			
SP-9001	1	¾		11.5	11	10.5	9.5	8	7	6	4							343	5	
SP-9002	2	1½		22	21.5	20.5	19	17.5	15	12	9							403	6.4	
SP-9004	4	3		42.5	42	40.5	38	33	28.5	23	18							524	9.3	
SP-9005	5	4		53	52	51	47.5	42.5	37	29	22							585	10.8	
SP-9006	6	5		64	63	60	56	50	43	34	27							645	12.2	
SP-9007*	7	5½		75	74	71	66	59	51	40	32							706	13.7	
SP-9010	10	7½		108	107	102	95	86	74	59	49							887	18	
SP-9013	13	10		141	139	133	124	112	95	75	60							1069	22.4	
SP-9017*	17	12½		184	182	175	163	147	126	100	80							1311	28.2	
SP-9020	20	15		216	213	206	192	175	147	116	95							1492	32.5	
SP-9022*	22	17½		239	237	228	212	191	163	130	105							1613	35.4	
SP-9024*	24	17½		260	257	247	230	208	178	140	115							1734	38.3	
SP-9027	27	20		292	288	277	260	234	200	158	128							1916	42.7	
SP-9029	29	25		315	311	300	279	251	215	170	138							2037	45.6	
SP-9031	31	25		335	330	318	298	269	230	181	148							2158	48.5	
SP-9033	33	25		355	350	337	315	285	243	191	157							2279	51.4	
SP-9036	36	30		391	385	371	348	313	268	210	170							2460	55.7	
SP-9038	38	30		410	405	390	365	330	282	222	180							2581	58.6	
SP-9040	40	30		433	428	412	384	346	296	235	190							2702	61.5	

\*It is recommended to use the next rating of horsepower available





**6" MODEL SP-150**  
50 Hz - 3000 RPM



**3" Discharge**



**Stainless Steel Coupling and Shaft**



**Stainless Steel Suction Strainer**



**Stainless Steel Diffuser**



**Stainless Steel Impeller and Split Cone**



**Stainless Steel Check Valve**

**SP SERIES PERFORMANCE CURVES**  
150 GPM MAXIMUM EFFICIENCY

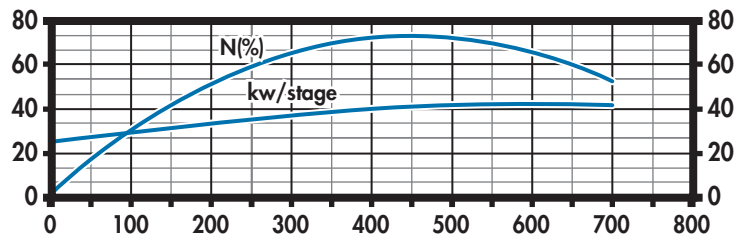
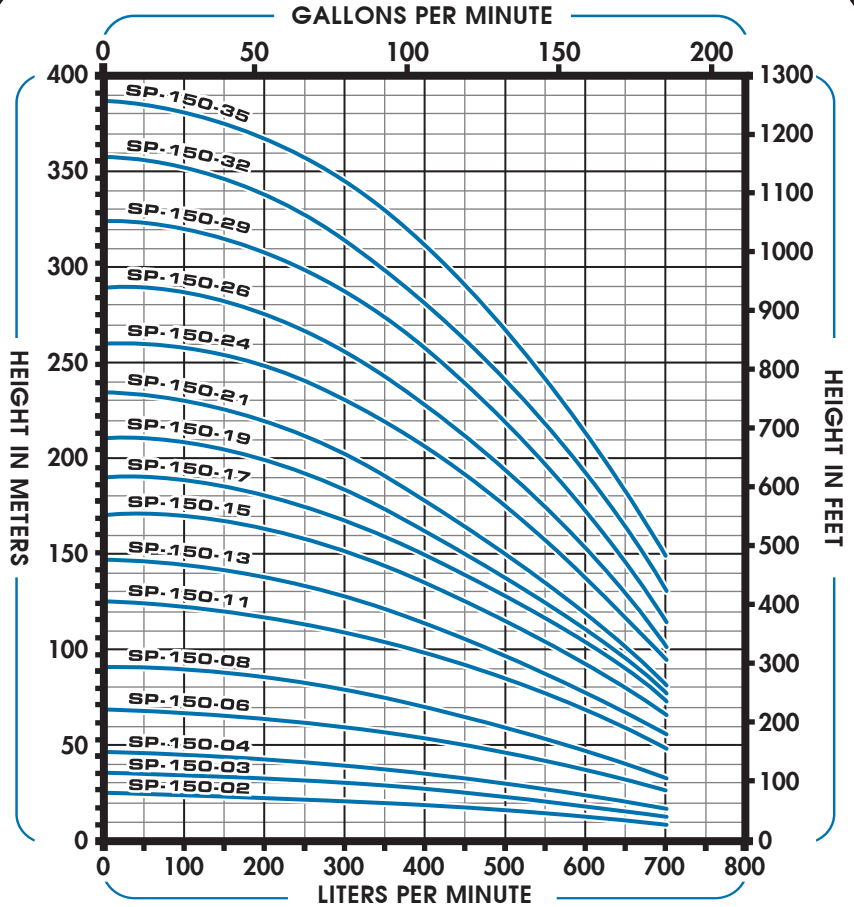

MODEL	STAGES	HP	Quantity Delivered																LENGTH mm	WEIGHT kg
			l/min	100	150	200	250	300	350	400	450	500	550	600	650	700				
			m <sup>3</sup> /h	6	9	12	15	18	21	24	27	30	33	36	39	42				
			Total Head in Meters																	
SP-150-2	2	3		23	22	21	20	19	18	17	16	15	13	11	9	6	462	8.4		
SP-150-3	3	4		33	32	31	30	29	28	26	24	22	20	17	14	11	558	10.1		
SP-150-4*	4	5½	E	43	42	41	40	38	36	34	31	28	26	23	19	15	654	11.8		
SP-150-6	6	7½	A	67	64	62	60	58	56	52	49	45	40	36	30	25	846	15.2		
SP-150-8	8	10	D	88	87	84	81	78	73	68	64	58	53	46	38	31	1038	18.6		
SP-150-11	11	15		122	120	117	112	108	102	97	90	93	76	67	57	47	1326	23.6		
SP-150-13	13	15	I	143	140	137	132	127	120	113	105	97	87	77	66	55	1518	27		
SP-150-15	15	20	N	168	166	162	157	150	142	134	124	113	102	90	77	65	1710	30.4		
SP-150-17	17	20		188	185	180	173	167	158	148	138	127	116	103	88	71	1902	33.8		
SP-150-19	19	25	M	208	205	199	192	182	172	161	150	137	125	110	94	77	2094	37.2		
SP-150-21	21	25	E	230	226	220	212	202	190	177	164	149	134	117	100	80	2286	40.6		
SP-150-24	24	30	T	258	254	248	240	2300	219	207	191	175	156	137	117	93	2574	45.6		
SP-150-26	26	30	R	287	282	275	266	255	242	227	212	194	173	152	127	100	2766	49		
SP-150-29*	29	35	S	319	314	307	298	287	273	257	240	220	196	170	143	113	3054	54.1		
SP-150-32	32	40		353	347	338	327	313	298	281	261	240	217	190	160	130	3342	59.2		
SP-150-35	35	40		382	377	368	358	346	329	311	290	267	240	211	180	148	3630	64.3		

\*It is recommended to use the next rating of horsepower available





**6" MODEL SP-230**  
50 Hz - 3000 RPM



**3" Discharge**



**Stainless Steel Coupling and Shaft**



**Stainless Steel Suction Strainer**



**Stainless Steel Diffuser**



**Stainless Steel Impeller and Split Cone**



**Stainless Steel Check Valve**

**SP SERIES PERFORMANCE CURVES**  
230 GPM MAXIMUM EFFICIENCY

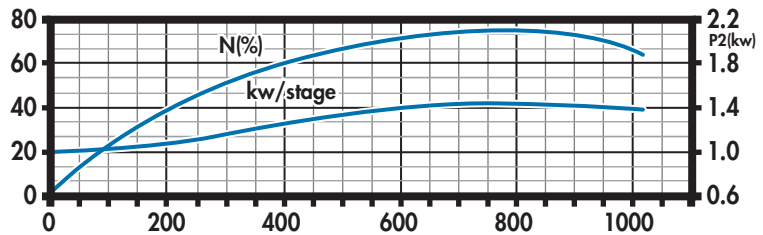
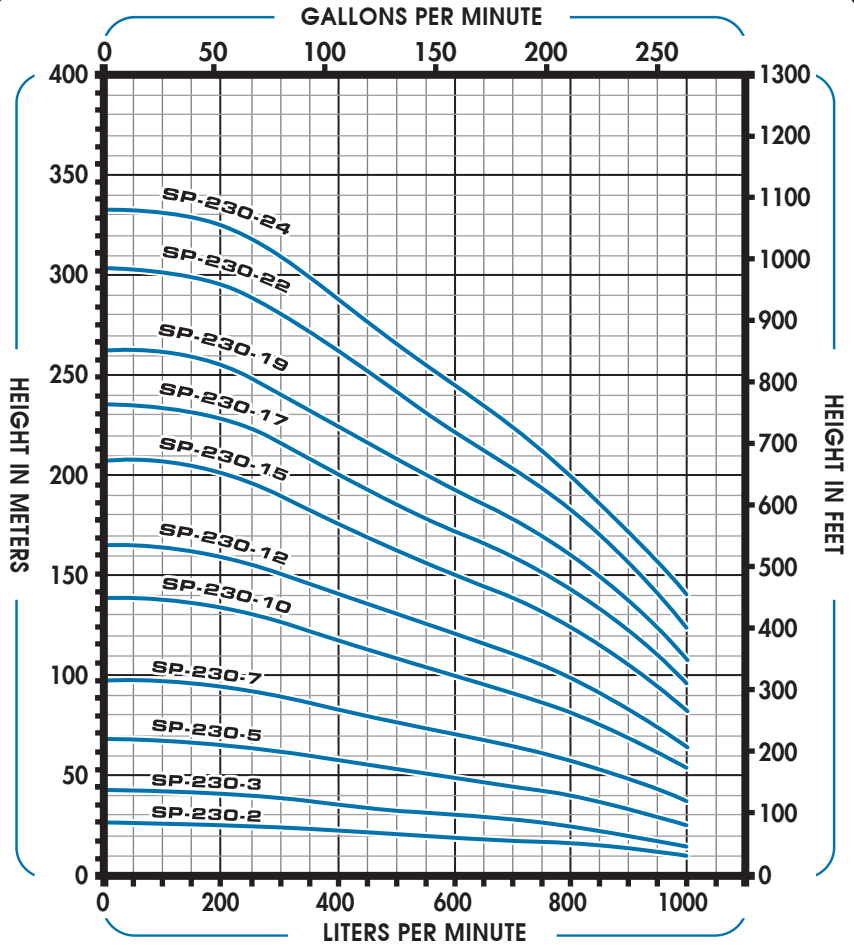

MODEL	STAGES	HP	Quantity Delivered														LENGTH mm	WEIGHT kg
			l/min	200	250	300	350	400	450	500	600	700	800	900	1000	1100		
			0	12	15	18	21	24	27	30	36	42	48	54	60	66		
			Total Head in Meters															
SP-230-2	2	4		24	23.5	23	22.5	22	21	20	18	17	15	12	9		496	9.2
SP-230-3C	3	5	H	35	34	32	31	29	28	27	24	22	19	15	10		609	11.5
SP-230-3	3	7½	E	40	39	38	37	35	34	33	29	27	23	18	14		609	11.5
SP-230-4C	4	7½	A	49	47	46	45	43	41	39	36	32	28	23	17		722	13.8
SP-230-5	5	10	D	65	63	61	59	57	55	53	48	44	39	32	24		835	16
SP-230-7	7	15	I	94	92	88	85	82	79	76	70	64	57	47	37		1061	20.6
SP-230-8C	8	15	N	100	98	95	92	88	85	82	76	69	61	51	39		1174	22.9
SP-230-10	10	20		133	130	127	122	117	112	107	98	90	80	67	53		1400	27.4
SP-230-12	12	25	M	158	155	150	145	140	135	130	120	110	98	83	64		1626	32
SP-230-15	15	30	E	200	195	189	183	177	169	163	150	138	124	105	81		1965	38.8
SP-230-17*	17	35	T	227	222	215	208	200	193	186	172	158	143	121	96		2191	43.4
SP-230-19	19	40	E	254	248	241	233	224	216	208	193	178	160	136	107		2417	47.9
SP-230-22	22	40	R	294	288	280	270	260	251	241	222	203	183	155	123		2756	54.8
SP-230-24	24	50	S	325	317	309	298	287	276	265	244	223	199	171	140		2982	59.3

\*It is recommended to use the next rating of horsepower available





**6" MODEL SP-300**  
50 Hz - 3000 RPM



**3" Discharge**



**Stainless Steel Coupling and Shaft**



**Stainless Steel Suction Strainer**



**Stainless Steel Diffuser**



**Stainless Steel Impeller and Split Cone**



**Stainless Steel Check Valve**

**SP SERIES PERFORMANCE CURVES**  
300 GPM MAXIMUM EFFICIENCY

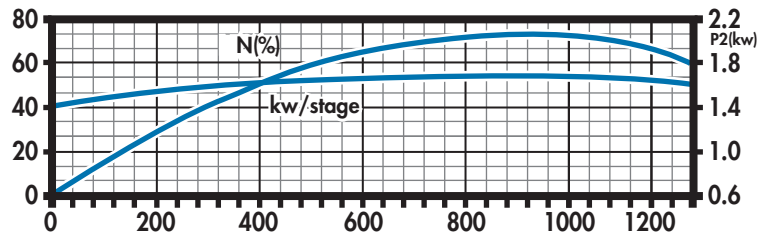
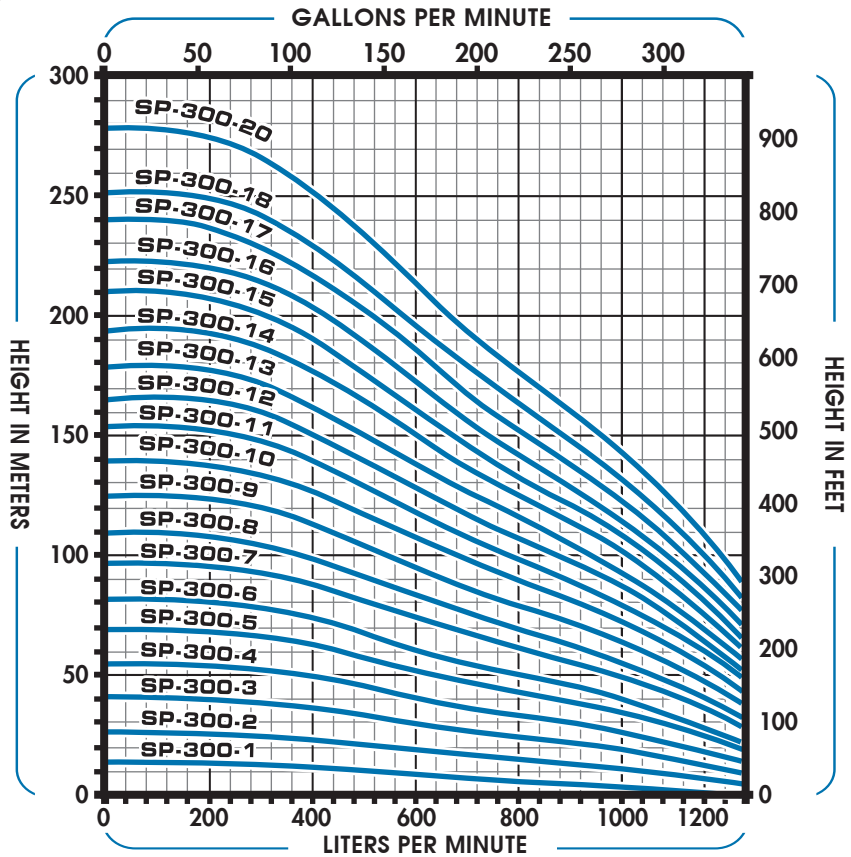

MODEL	STAGES	HP	Quantity Delivered																LENGTH mm	WEIGHT kg						
			Total Head in Meters																							
			l/min 0	300	350	400	450	500	600	700	800	900	1000	1100	1200	1300	18	21			24	27	30	36	42	48
SP-300-1	1	3		13	12.5	12	11.5	11	10	8	7	6	5	4	2	1	383	6.9								
SP-300-2	2	5		26	25	24	23	22	20	18	16	14	13	11	8	5	496	9.2								
SP-300-3	3	7½		40	39	38	37	36	32	28	26	24	22	18	14	10	609	11.5								
SP-300-4	4	10		53	52	51	48	47	43	38	35	32	28	25	20	14	722	13.7								
SP-300-5*	5	12½	HEAD IN METERS	67	66	64	62	60	55	50	46	42	38	33	27	19	835	16								
SP-300-6	6	15		79	78	76	73	70	64	58	53	48	44	38	32	23	948	18.3								
SP-300-7*	7	17½		94	92	89	86	84	77	70	64	59	54	47	40	29	1061	20.6								
SP-300-8	8	20		106	104	101	97	94	87	80	73	67	60	53	44	33	1174	22.9								
SP-300-9	9	25		122	118	116	112	108	99	91	83	76	69	61	51	38	1287	25.1								
SP-300-10	10	25		135	132	128	125	120	111	102	95	87	78	68	57	45	1400	27.4								
SP-300-11	11	30		148	146	142	137	132	122	112	103	95	86	76	64	49	1513	29.7								
SP-300-12	12	30		162	157	153	148	143	133	122	112	103	94	83	68	53	1626	32								
SP-300-13*	13	35		173	169	165	160	155	143	132	121	110	100	87	73	57	1739	34.3								
SP-300-14*	14	35		188	184	180	175	168	156	142	130	120	109	96	80	63	1852	36.5								
SP-300-15*	15	35		203	197	193	187	180	166	152	138	127	116	103	86	67	1965	38.8								
SP-300-16	16	40		216	211	206	200	193	178	162	148	135	123	108	92	72	2078	41.1								
SP-300-17	17	50		230	226	220	214	207	192	175	158	145	132	116	97	78	2191	43.4								
SP-300-18	18	50		243	238	233	226	218	202	185	170	155	141	126	107	83	2304	45.7								
SP-300-20	20	50		267	263	256	248	239	220	201	184	168	153	136	115	90	2530	50.2								

\*It is recommended to use the next rating of horsepower available





**8" MODEL SP-400**  
50 Hz - 3000 RPM



5" Discharge



Stainless Steel Coupling and Shaft



Stainless Steel Bowl w/Diffuser



Cast Stainless Steel Discharge w/Check Valve



Cast Stainless Steel Suction W/NEMA Mounting Bracket



Stainless Steel Impeller and Split Cone

**SP SERIES PERFORMANCE CURVES**  
400 GPM MAXIMUM EFFICIENCY

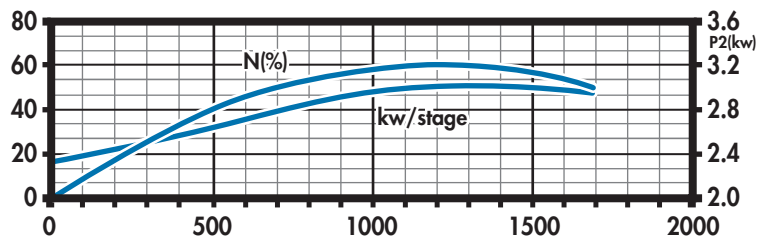
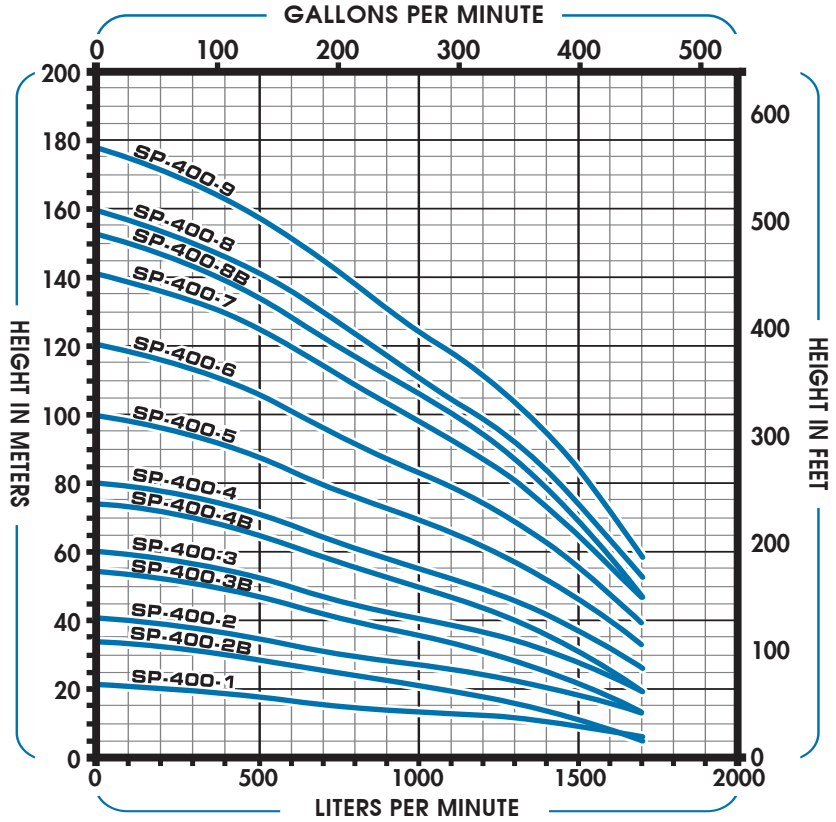

MODEL	STAGES	HP	Quantity Delivered																LENGTH mm	WEIGHT kg
			Total Head in Meters																	
			l/min	0	200	300	400	500	600	700	800	900	1100	1300	1500	1700	1800			
			m <sup>3</sup> /h	0	12	18	24	30	36	42	48	54	66	78	90	102	108			
SP-400-1	1	7½		20	19.5	19	18	17	16	15	14	13	12	9	7		618	25.1		
SP-400-2-B	2	7½		33	32	30	28	27	26	25	23	20	16	11	6		746	28.7		
SP-400-2	2	10		39	38	37	35	33	32	30	28	26	23	18	13		746	28.7		
SP-400-3-B*	3	12½		53	51	49	47	45	43	41	38	34	28	22	13		874	32.3		
SP-400-3	3	15		58	57	55	53	50	47	45	43	39	35	28	20		874	32.3		
SP-400-4-B*	4	17½		72	70	68	65	62	59	56	53	57	40	31	20		1003	35.9		
SP-400-4	4	20		77	76	74	71	67	64	61	58	53	46	37	27		1003	35.9		
SP-400-5	5	25		96	94	92	88	84	80	76	73	66	57	46	33		1131	39.5		
SP-400-6	6	30		116	113	110	106	101	96	92	88	80	70	56	40		1259	43		
SP-400-7*	7	35		136	133	130	126	120	115	109	104	93	81	65	47		1387	46.6		
SP-400-8-B*	8	35		147	143	139	134	129	123	117	112	101	87	69	47		1515	50.2		
SP-400-8	8	40		153	150	146	141	135	129	123	117	105	93	75	53		1515	50.2		
SP-400-9	9	40		171	167	163	158	152	154	138	131	118	104	84	58		1644	53.8		

\*It is recommended to use the next rating of horsepower available





**8" MODEL SP-400**  
50 Hz - 3000 RPM



5" Discharge



Stainless Steel Coupling and Shaft



Stainless Steel Bowl w/Diffuser



Cast Stainless Steel Discharge w/Check Valve



Cast Stainless Steel Suction W/NEMA Mounting Bracket



Stainless Steel Impeller and Split Cone

**SP SERIES PERFORMANCE CURVES**  
400 GPM MAXIMUM EFFICIENCY

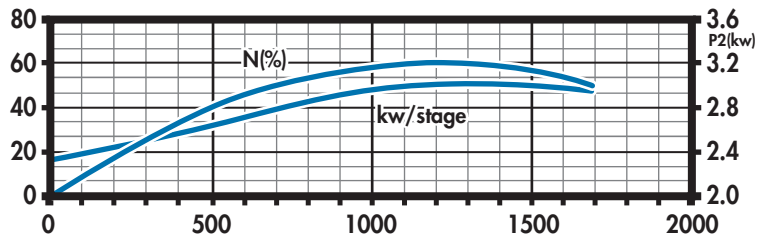
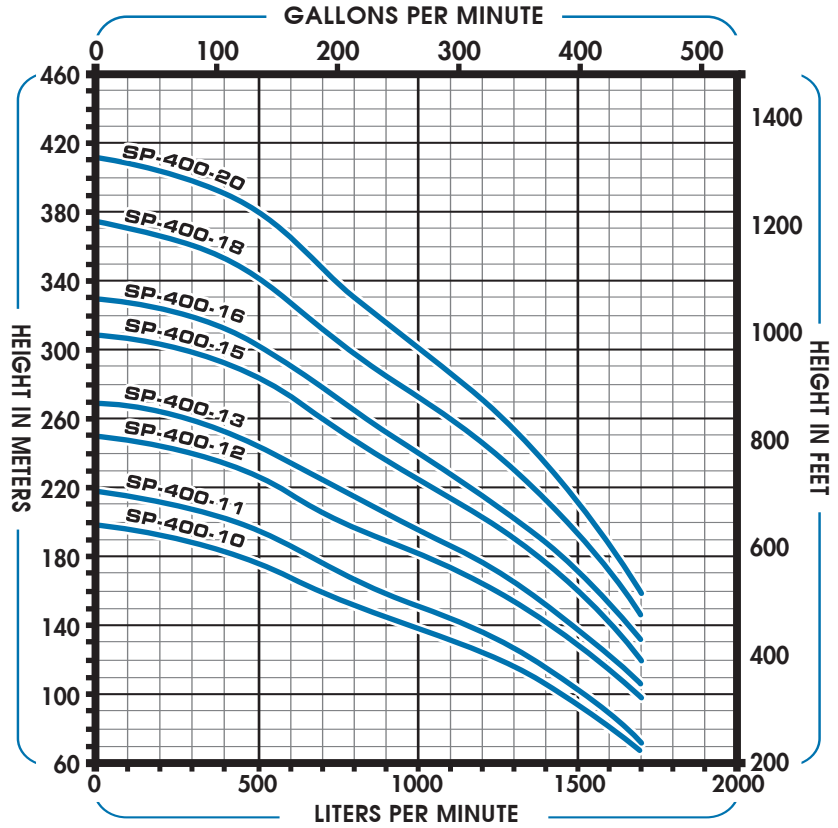

MODEL	STAGES	HP	Quantity Delivered																LENGTH mm	WEIGHT kg
			Total Head in Meters																	
			l/min m <sup>3</sup> /h	0	200	300	400	500	600	700	800	900	1100	1300	1500	1700	1800			
SP-400-10	10	50		193	188	183	177	168	160	152	145	132	117	94	68		1772	57.4		
SP-400-11	11	50		211	207	202	195	186	176	167	159	154	128	104	74		1900	61		
SP-400-12	12	60		244	240	234	227	217	207	198	190	173	154	130	99		2039	66		
SP-400-13	13	75		263	259	252	244	235	224	214	205	187	166	139	107		2168	69.6		
SP-400-15	15	75		302	298	292	284	273	260	248	237	215	191	160	120		2424	76.8		
SP-400-16	16	85		322	318	312	302	290	278	265	252	228	202	172	132		2552	80.4		
SP-400-18	18	85		365	359	352	341	328	312	298	285	260	230	193	147		2809	87.6		
SP-400-20	20	100		402	397	389	379	364	347	330	315	287	254	212	159		3065	94.8		





**8" MODEL SP-500**  
50 Hz - 3000 RPM



5" Discharge



Stainless Steel Coupling and Shaft

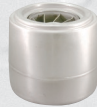

Stainless Steel Bowl w/Diffuser



Cast Stainless Steel Discharge w/Check Valve



Cast Stainless Steel Suction W/NEMA Mounting Bracket



Stainless Steel Impeller and Split Cone

**SP SERIES PERFORMANCE CURVES**  
500 GPM MAXIMUM EFFICIENCY

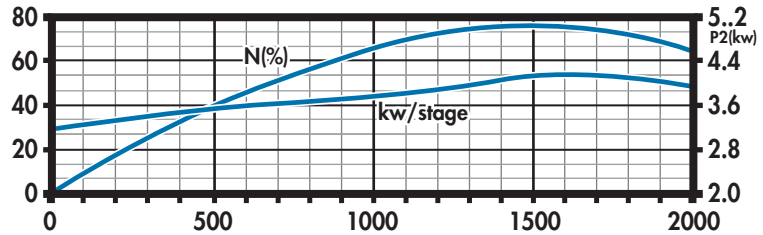
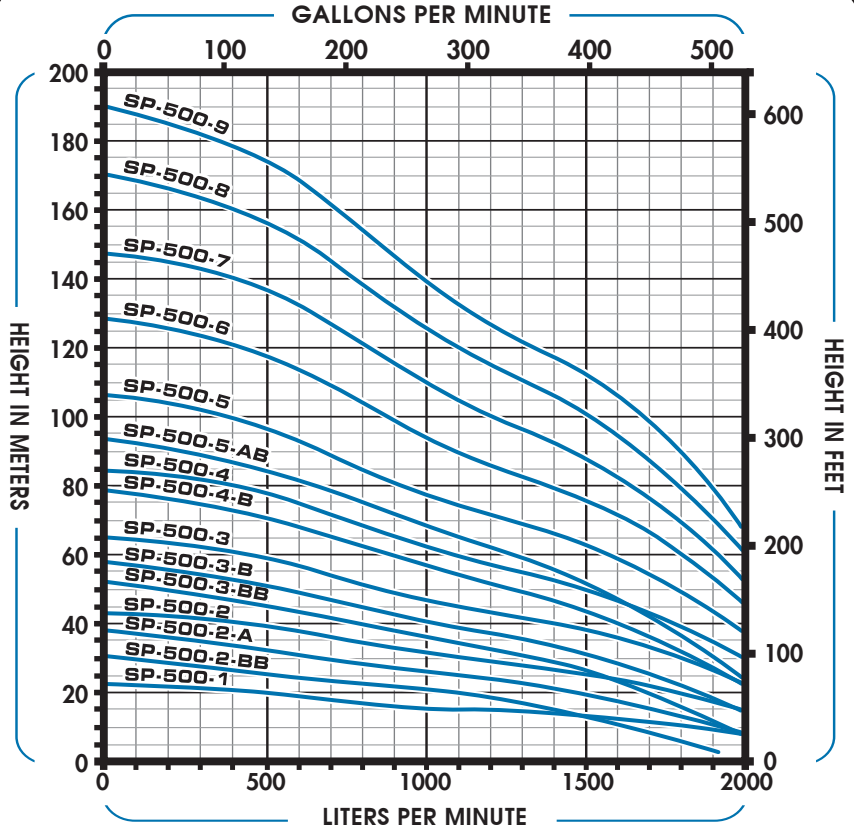

MODEL	STAGES	HP	Quantity Delivered																LENGTH mm	WEIGHT kg
			Total Head in Meters																	
			l/min	0	300	400	500	600	700	800	1000	1200	1400	1600	1800	2000				
			m <sup>3</sup> /h	0	18	24	30	36	42	48	60	72	84	96	108	120				
SP-500-1	1	7 1/2		21	20	19	18	17.5	17	15	14	13	12	10	8		618	25.1		
SP-500-2-BB	2	7 1/2		27	26	25	24	23	22	20	18	15	11	5	0		746	28.7		
SP-500-2-A	2	10		34	33	32	31	30	28	26	24	21	17	13	8		746	28.7		
SP-500-2	3	12 1/2		41	40	39	37	36	34	31	29	26	23	20	15		746	28.7		
SP-500-3-BB	3	12 1/2		48	46	45	43	41	40	36	33	28	23	16	8		874	32.3		
SP-500-3-B	3	15		54	53	51	49	47	45	41	37	33	28	22	15		874	32.3		
SP-500-3	3	17 1/2		62	60	59	57	54	51	47	43	40	35	30	23		874	32.3		
SP-500-4-B	4	20		74	73	71	68	65	62	56	52	47	40	32	22		1003	35.9		
SP-500-4	4	25		82	80	78	75	72	68	62	57	53	47	39	30		1003	35.9		
SP-500-5-AB	5	25		89	87	84	82	78	75	68	62	55	47	36	25		1131	39.5		
SP-500-5	5	30		102	100	97	94	90	85	77	72	66	59	50	38		1131	35.9		
SP-500-6	6	35		123	121	118	114	110	104	94	86	79	72	60	46		1259	43		
SP-500-7	7	40		143	140	137	132	127	121	110	101	93	83	70	53		1387	46.6		
SP-500-8	8	50		164	160	157	152	146	139	126	116	106	95	80	62		1515	50.2		
SP-500-9	9	50		182	179	175	169	163	155	140	128	118	106	90	68		1644	53.8		





**8" MODEL SP-500**  
50 Hz - 3000 RPM



**5" Discharge**



**Stainless Steel Coupling and Shaft**

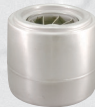

**Stainless Steel Bowl w/Diffuser**



**Cast Stainless Steel Discharge w/Check Valve**



**Cast Stainless Steel Suction W/NEMA Mounting Bracket**



**Stainless Steel Impeller and Split Cone**

**SP SERIES PERFORMANCE CURVES**  
500 GPM MAXIMUM EFFICIENCY

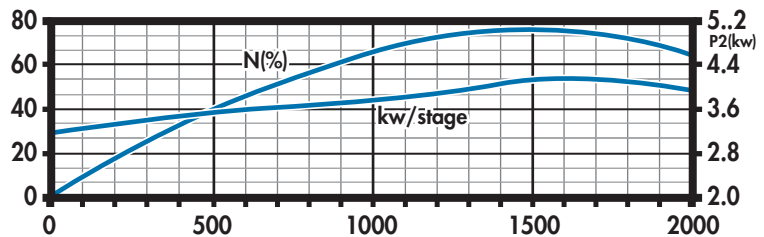
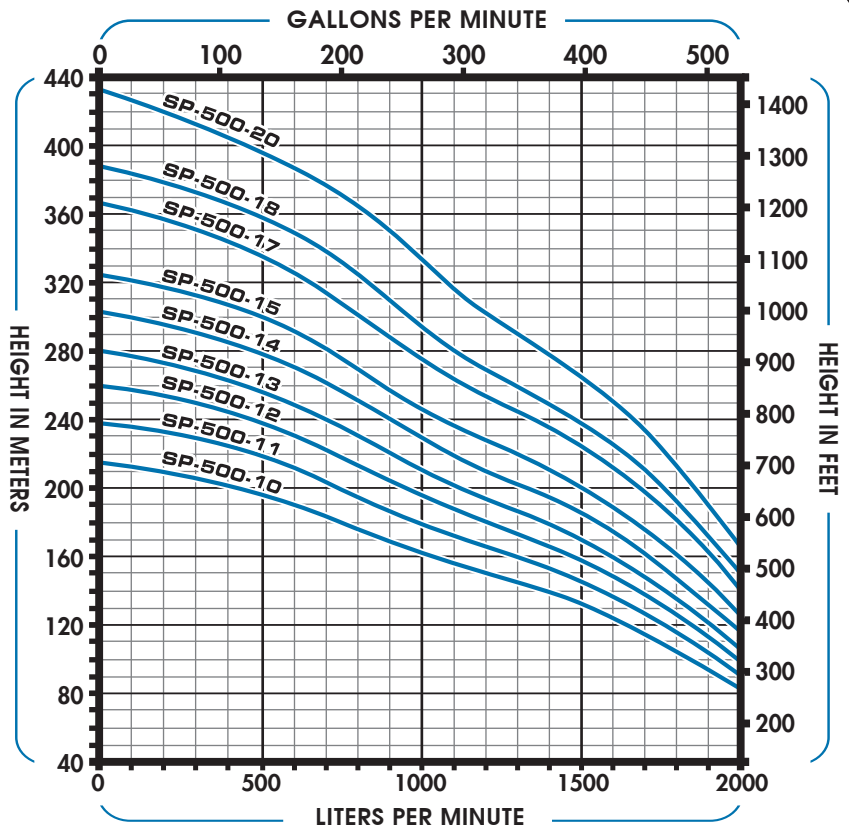

MODEL	STAGES	HP	Quantity Delivered																LENGTH mm	WEIGHT kg
			l/min	300	400	500	600	700	800	1000	1200	1400	1600	1800	2000					
			m <sup>3</sup> /h	18	24	30	36	42	48	60	72	84	96	108	120					
			Total Head in Meters																	
SP-500-10	10	60	206	201	197	190	183	177	162	150	140	124	105	82	1783	58.8				
SP-500-11	11	75	230	225	220	212	204	196	180	167	152	137	116	90	1911	62.4				
SP-500-12	12	75	250	245	240	231	222	214	197	181	167	150	126	99	2039	66				
SP-500-13	13	75	268	263	258	250	240	230	210	195	180	160	135	106	2168	69.6				
SP-500-14	14	85	291	286	280	271	261	251	230	210	194	174	147	116	2296	73.2				
SP-500-15	15	100	312	308	300	292	281	270	248	228	210	190	160	126	2424	76.7				
SP-500-17	17	100	350	344	336	327	316	302	277	255	235	212	180	140	2680	84				
SP-500-18	18	125	372	366	360	350	340	326	296	270	250	227	192	150	2809	87.6				
SP-500-20	20	125	412	406	397	388	378	365	333	302	279	251	214	166	3065	94.8				